



Installation instructions for PZ4AL-2793-00, PZ4AL-2794-00
Under Run Protective Shield Fuel Tank

TOYOTA RAV4



LEXUS NX



	RAV4	NX
Model year:	2012	2014
Applicability:	all sfx	all sfx except NX300h
Part Number:		Steel: PZ4AL-2793-00 Aluminium: PZ4AL-2794-00
 Weight:		Steel: 14.10 kg Aluminium: 10.09 kg
 Installation Time:		30 min

PZ4AL-02793-00, PZ4AL-02794-00

A

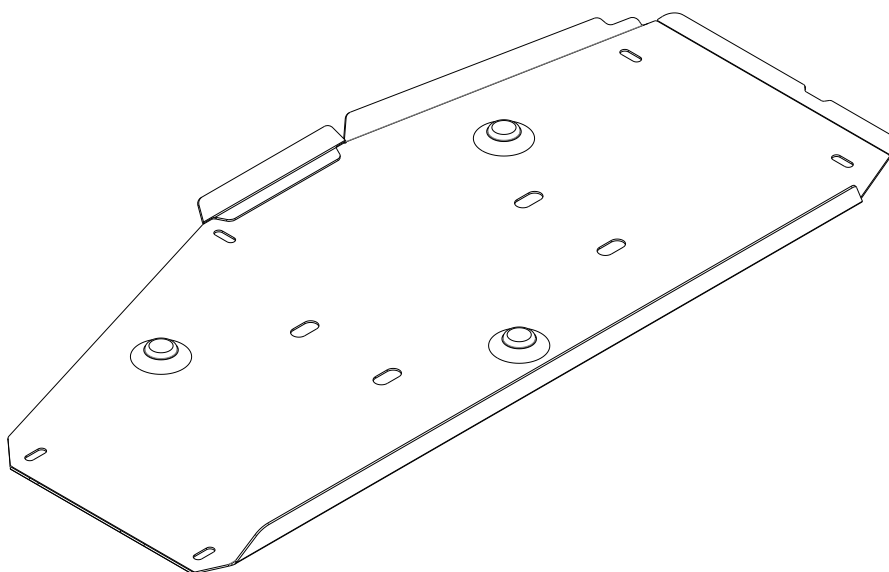

PZ4AL-02793-60

B

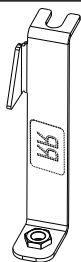

1x

C



1x

D

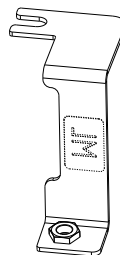

1x

E

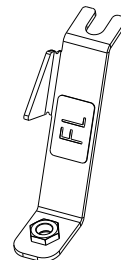

1x

F

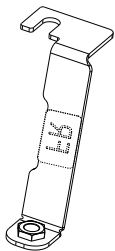

1x

G

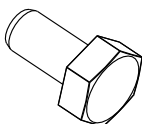

M10x30

5x

H

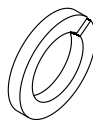

d=10

5x

I

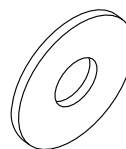

d=10

5x

J

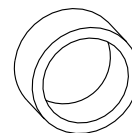

h=10

1x

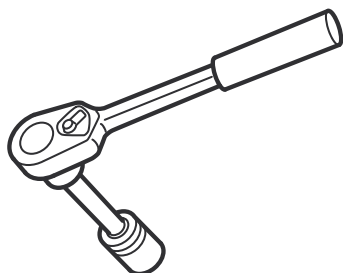

17 mm



1

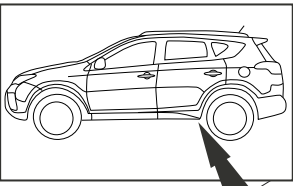

FWD

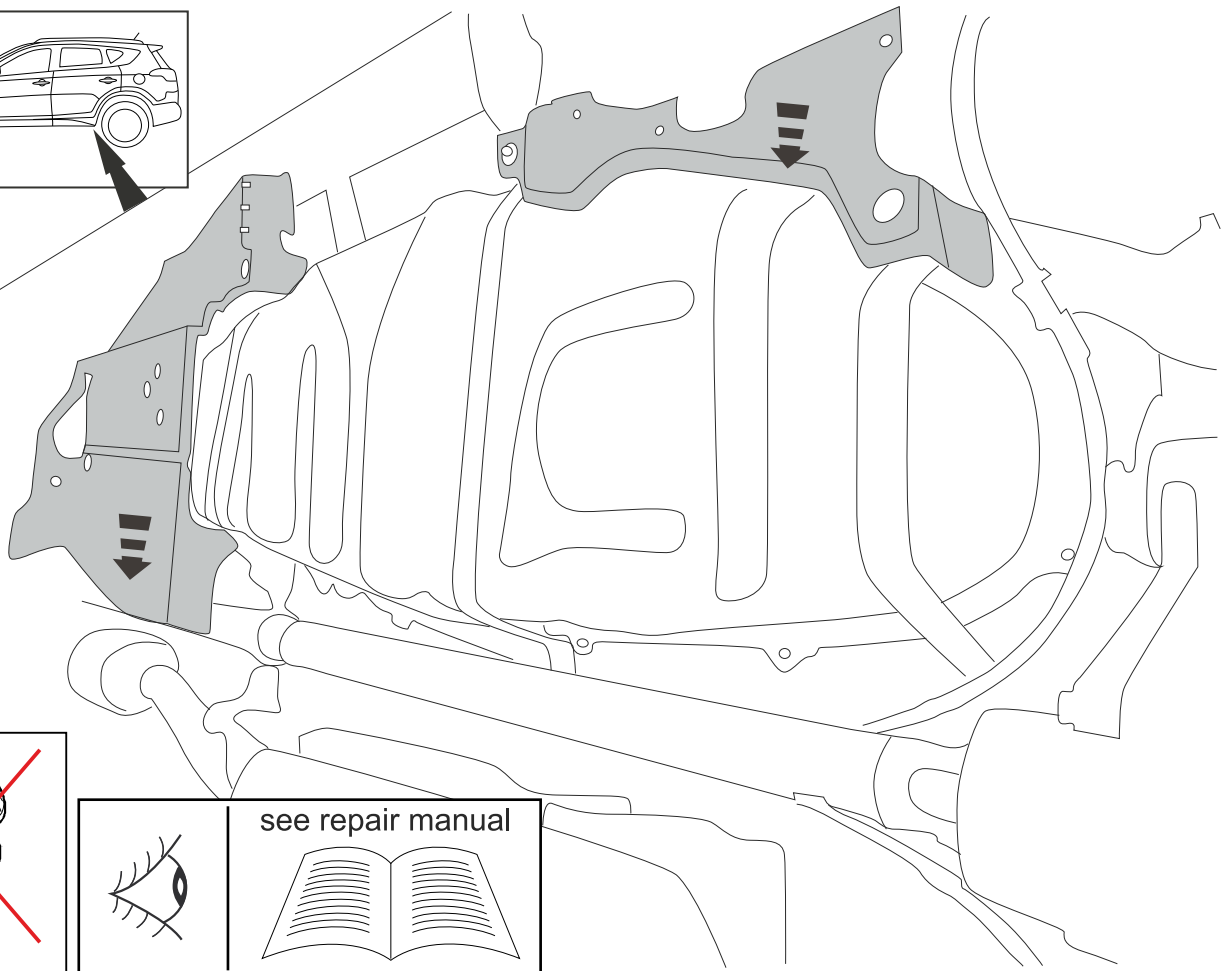

see repair manual

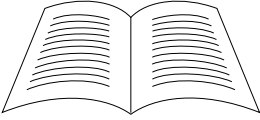
2

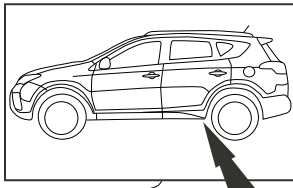

FWD

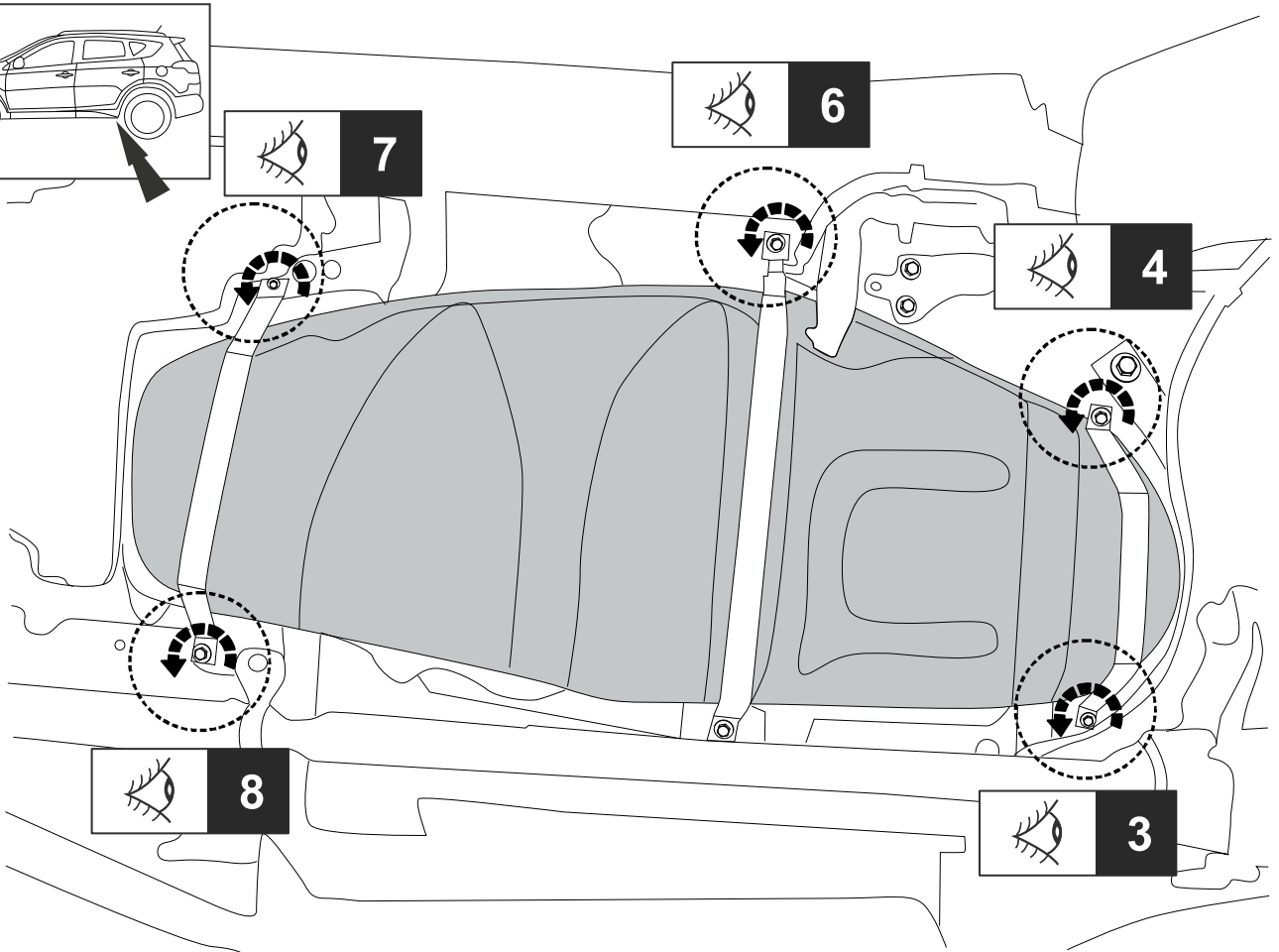

3

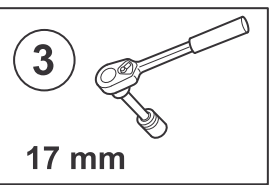
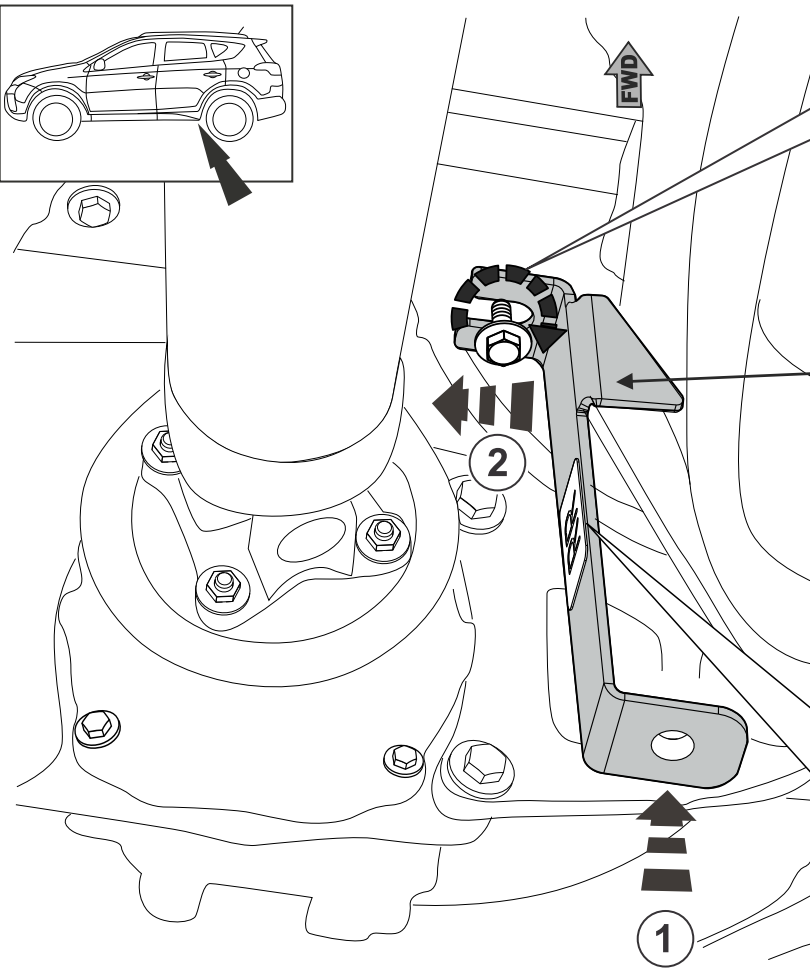
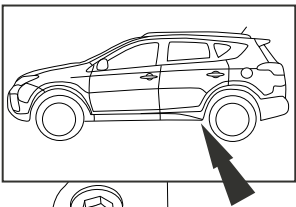

3

17 mm



4

45 Nm



4

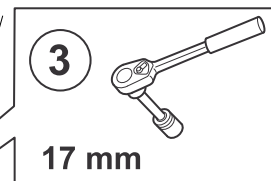
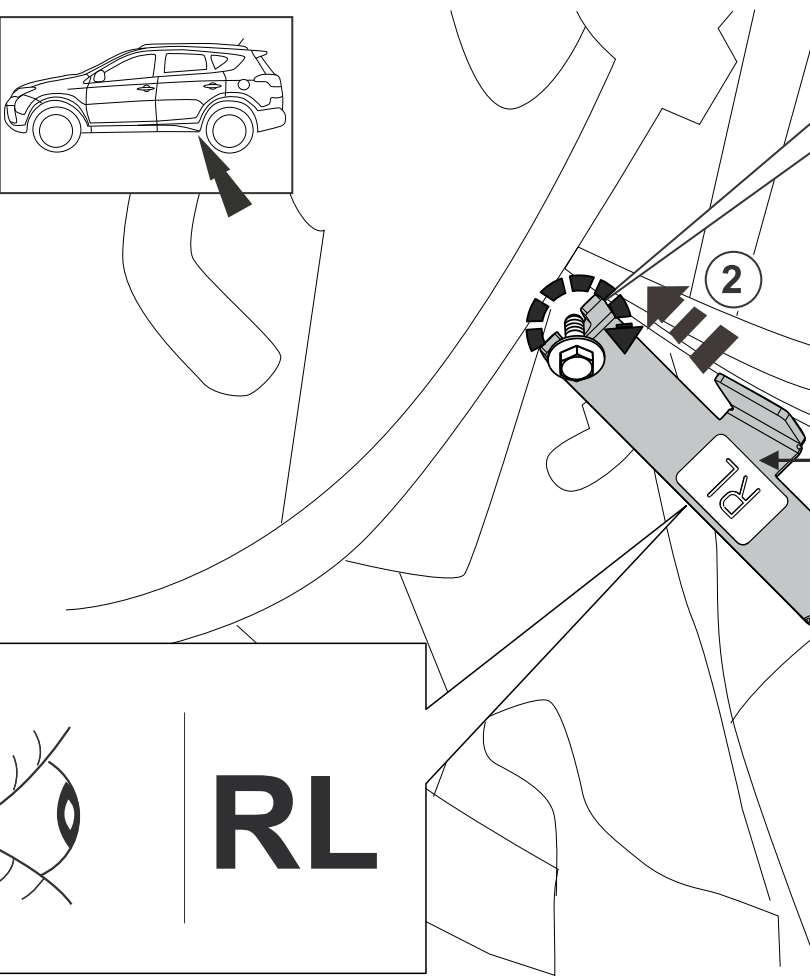
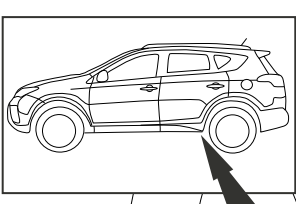

3

17 mm



4

45 Nm



5

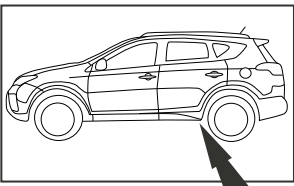

FWD

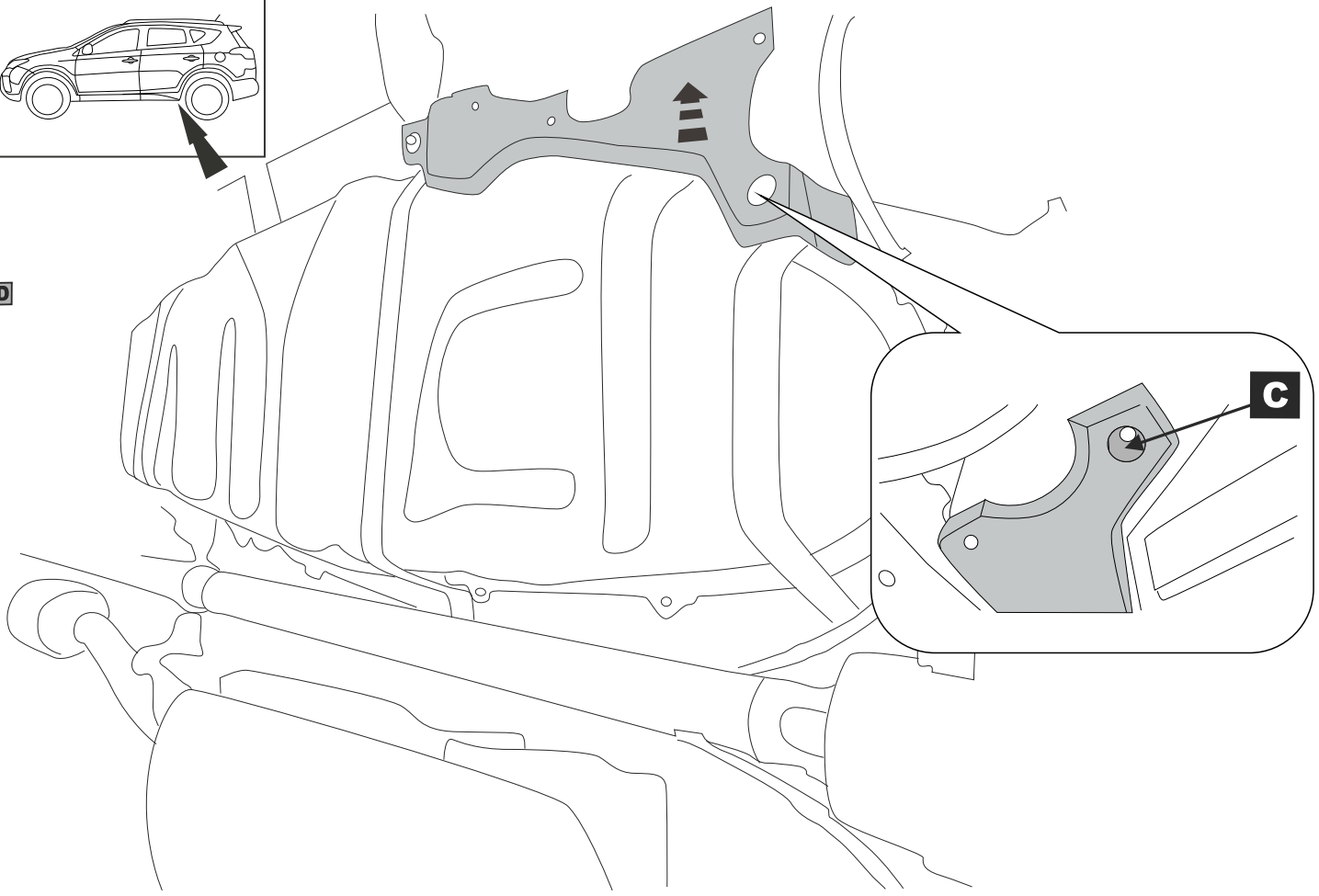

6

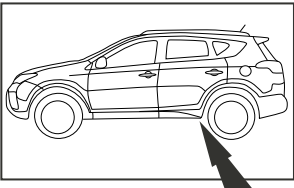

FWD

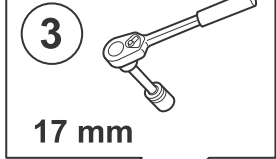

2

D

1



7

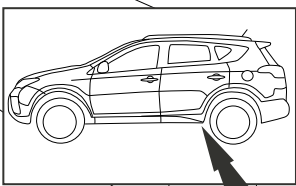

3

17 mm

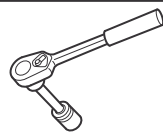

4

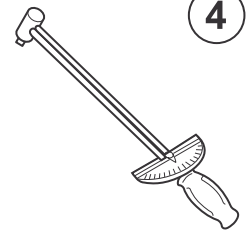

45 Nm

2



1



E



8

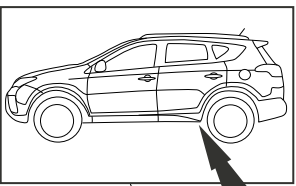

3

17 mm

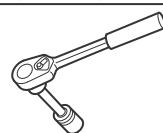

4



45 Nm

2



FWD



1



F



9

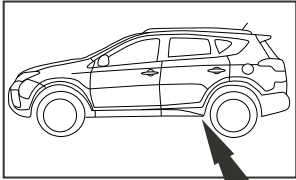

FWD



see repair manual



10

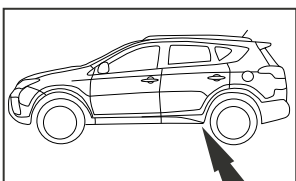

FWD

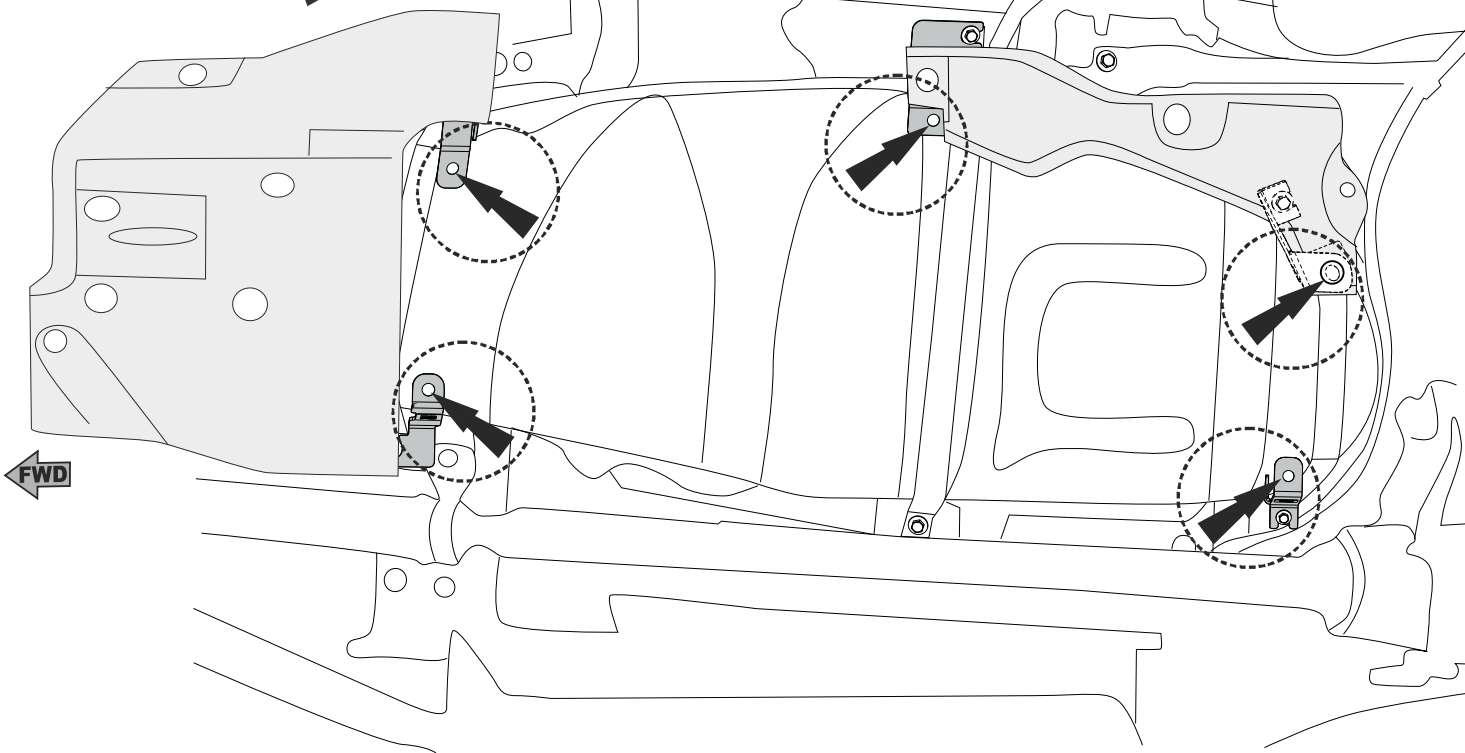

11

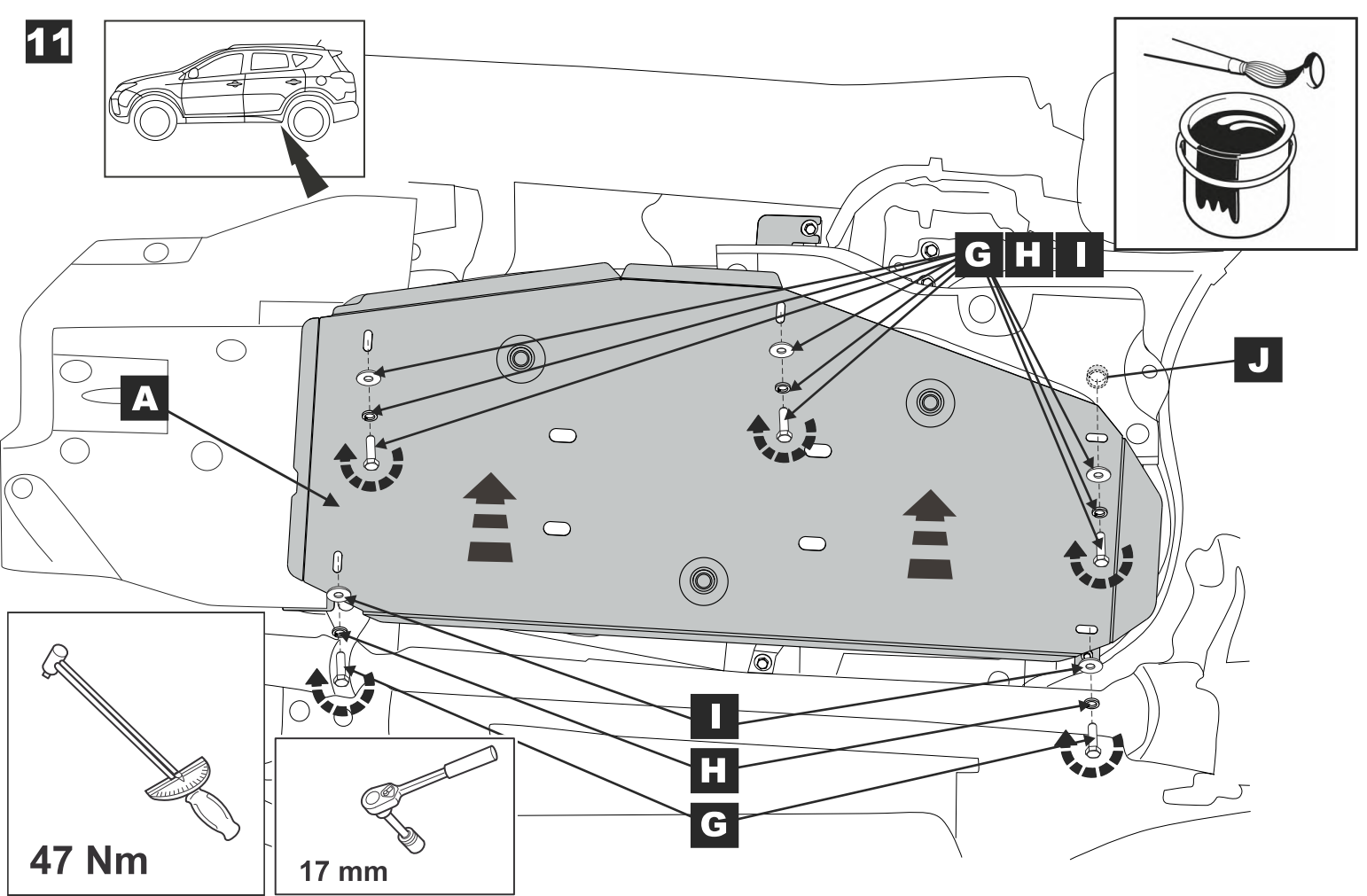
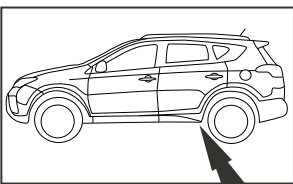

12

